

# NÁSTREŠNÉ VENTILÁTORY TORRETTE TR E

S HORIZONTÁLNYM VÝFUKOM

www.vortice.sk

- Odsávacie ventilátory vhodné pre montáž na strechy obytných, komerčných a priemyselných budov.
- 20 modelov s horizontálnym výfukom a výkonom až 18000m<sup>3</sup>/h.
- Ventilátory s asynchrónnym indukčným motorom, s triedou ochrany IP55 a guľôčkovými ložiskami.
- Kryt ventilátora vyrobený z ocele s epoxidovým povrchovým náterom pre zabezpečenie odolnosti voči korózii a predĺženie životnosti.
- Aerodynamicky tvarovaný nasávací otvor z ocelového plechu s polyesterovou povrchovou úpravou.
- Obežné koleso z pozinkovanej ocele so samočistiteľnými, dozadu zahnutými lopatkami, chránené ochrannou mriežkou z nehrdzavejúcej ocele.
- Vhodný na odsávanie čiastočne prašného vzduchu alebo dymu, neagresívnej a nekorozívnej vzdušiny bez kyselín. Nevhodné pre odsávanie vzduchu priamo z krbov alebo kotlov.
- Bezpečnostné lanko pre ukotvenie ventilátora k montážnemu základu.
- Závesné oká pre jednoduchú manipuláciu pri zdvíhaní a transporte.
- Zariadenie musí byť uzemnené.



## Príklady montáže

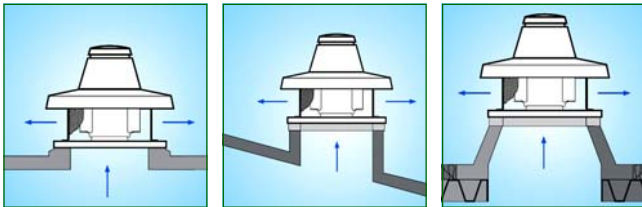

Jednoduchá a ľahká montáž na akýkoľvek typ strechy.

## Technické parametre

	Kód	El. napájanie V~50 Hz	El. príkon [kW]	Prúd [A]	Póly	[Ot/min]	Vzduchový výkon		Výtlak [Pa]	Akustický tlak Lp (3m) [dB(A)]	Hmotnosť [kg]	Krytie IP	Max. teplota [°C]
							[m <sup>3</sup> /h]	[l/s]					
TRM 10 E 4P	15115	230	0,1	0,5	4	1400	1100	306	216	56	14,5	55	90
TRM 15 E 4P	15205	230	0,15	0,7	4	1400	1400	389	255	58,5	15	55	60
TRM 20 E 4P	15216	230	0,28	1,3	4	1415	2600	722	353	62	22	55	85
TRM 30 E 4P	15356	230	0,4	1,8	4	1425	3300	917	432	67	23	55	70
TRM 50 E 4P	15556	230	0,8	3,7	4	1480	4800	1333	540	72,5	28	55	80
TRM 70 E 4P	15070	230	1,0	4,35	4	1415	6400	1778	662	77	79	55	90
TRT 10 E 4P	15155	400	0,1	0,3	4	1400	1100	306	216	56	14,5	55	90
TRT 15 E 4P	15255	400	0,15	0,3	4	1400	1400	389	255	58,5	15	55	90
TRT 20 E 4P	15215	400	0,3	0,6	4	1400	2700	750	343	62	22	55	90
TRT 30 E 4P	15355	400	0,4	0,75	4	1400	3200	889	451	67	23	55	90
TRT 50 E 4P	15555	400	0,8	1,45	4	1400	4900	1361	598	72,5	28	55	90
TRT 70 E 4P	15071	400	0,95	1,85	4	1440	6400	1778	677	77	77	55	90
TRT 70 E 6P	15072	400	0,6	1,3	6	950	7000	1944	373	74	80	55	90
TRT 100 E 4P	15073	400	1,9	3,25	4	1420	10000	2778	829	84	81	55	40
TRT 100 E 6P	15074	400	1,1	2,3	6	950	10800	3000	471	77	117	55	85
TRT 100 E 8P	15075	400	0,93	2,1	8	715	11000	3056	334	71	127	55	80
TRT 150 E 6P	15076	400	1,93	3,45	6	930	15000	4167	598	80	128	55	55
TRT 150 E 8P	15077	400	1,6	3,1	8	715	15000	4167	441	74	132	55	75
TRT 180 E 6P	15078	400	3,1	5,95	6	970	16000	4444	775	83	130	55	60
TRT 210 E 6P	15079	400	3,4	6,4	6	980	18000	5000	775	84	132	55	50

## Rozměry (mm)

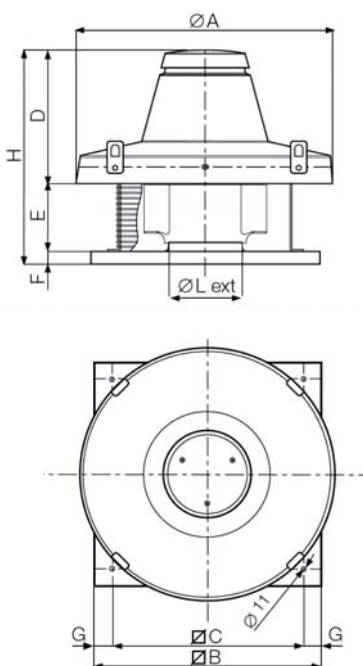

	kód	øA	∅B	∅C	D	E	F	G	H	øL
<b>TRM 10 E 4P</b>	15115	600	410	357	310	108	38	26,5	456	170
<b>TRM 15 E 4P</b>	15205	600	410	357	310	108	38	26,5	456	182
<b>TRM 20 E 4P</b>	15216	780	550	500	398	128	38	25	564	219
<b>TRM 30 E 4P</b>	15356	780	550	500	398	146	38	25	582	244
<b>TRM 50 E 4P</b>	15556	780	550	500	398	173	38	25	609	278
<b>TRM 70 E 4P</b>	15070	1015	830	750	449	283	38	40	770	328
<b>TRT 10 E 4P</b>	15155	600	410	357	310	108	38	26,5	456	170
<b>TRT 15 E 4P</b>	15255	600	410	357	310	108	38	26,5	456	182
<b>TRT 20 E 4P</b>	15215	780	550	500	398	128	38	25	564	219
<b>TRT 30 E 4P</b>	15355	780	550	500	398	146	38	25	582	244
<b>TRT 50 E 4P</b>	15555	780	550	500	398	173	38	25	609	278
<b>TRT 70 E 4P</b>	15071	1015	830	750	449	283	38	40	770	328
<b>TRT 70 E 6P</b>	15072	1015	830	750	449	283	38	40	770	365
<b>TRT 100 E 4P</b>	15073	1015	830	750	449	283	38	40	770	365
<b>TRT 100 E 6P</b>	15074	1165	980	900	605	383	38	40	1026	415
<b>TRT 100 E 8P</b>	15075	1165	980	900	605	383	38	40	1026	465
<b>TRT 150 E 6P</b>	15076	1165	980	900	605	383	38	40	1026	465
<b>TRT 150 E 8P</b>	15077	1165	980	900	605	383	38	40	1026	520
<b>TRT 180 E 6P</b>	15078	1165	980	900	605	383	38	40	1026	520
<b>TRT 210 E 6P</b>	15079	1165	980	900	605	383	38	40	1026	520

## Tlakové - výkonové křivky

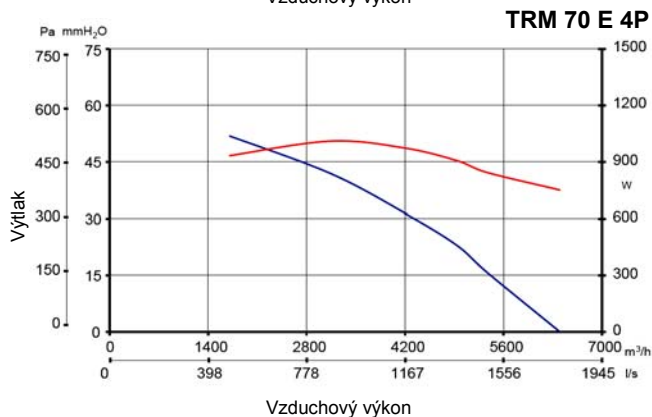
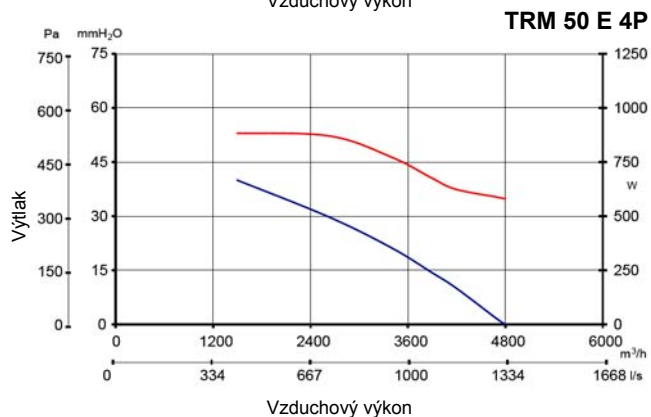
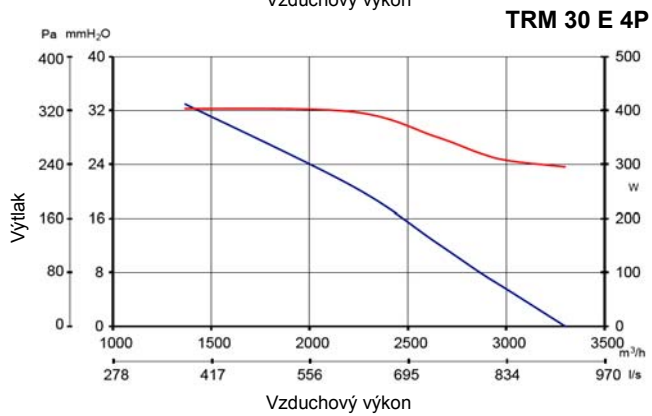
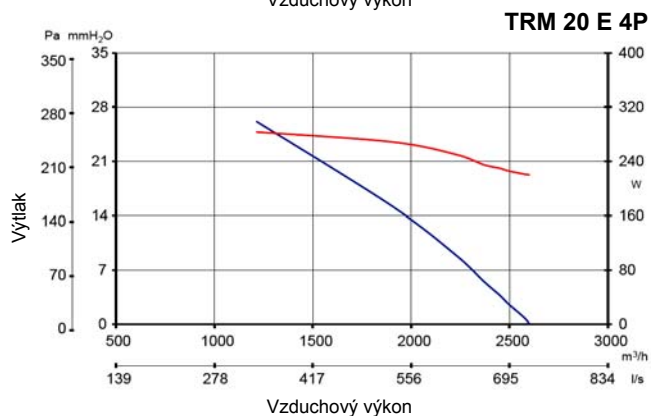
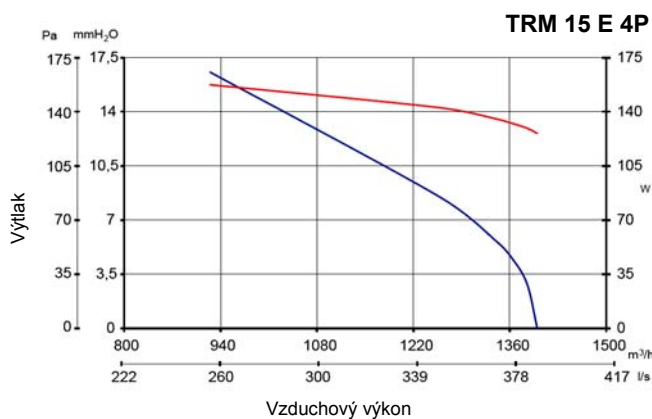
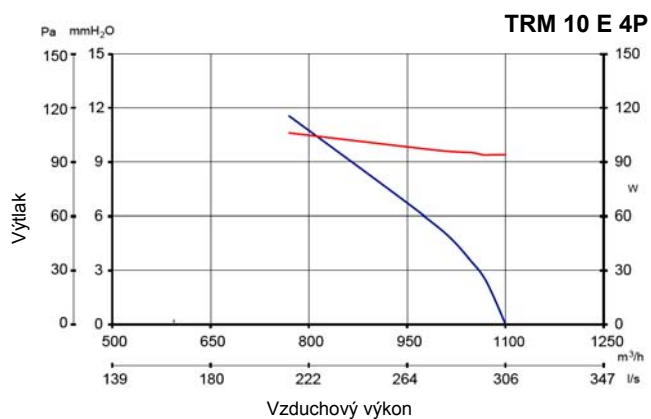

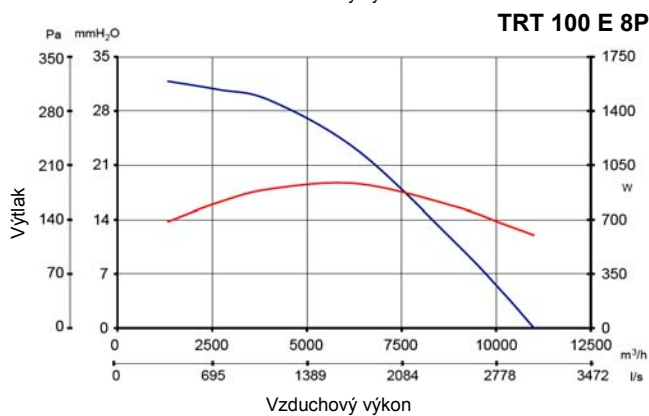
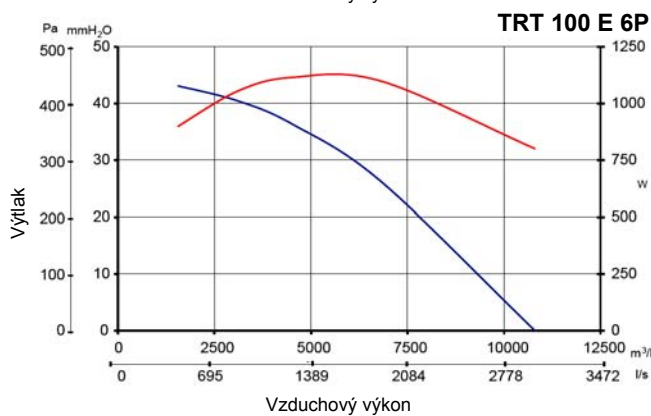
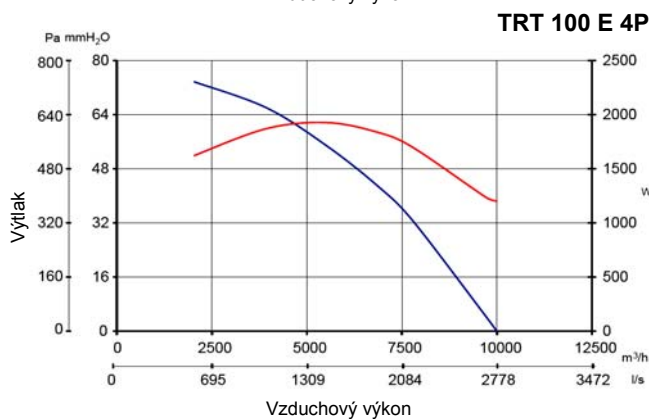
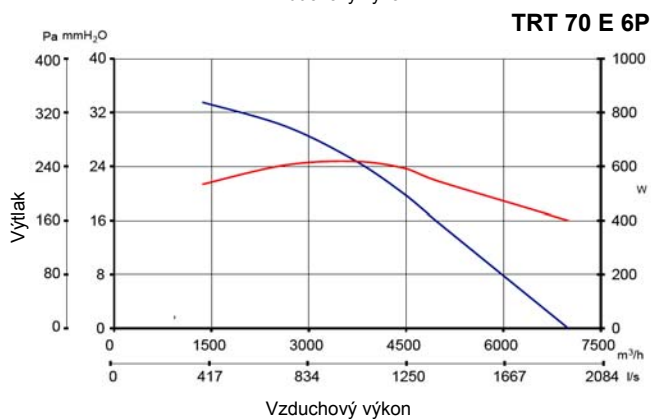
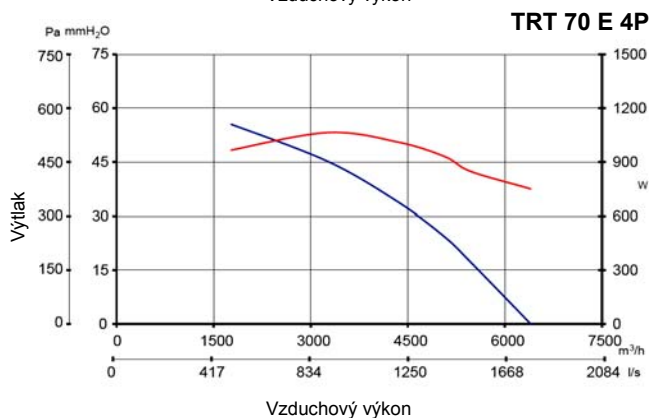
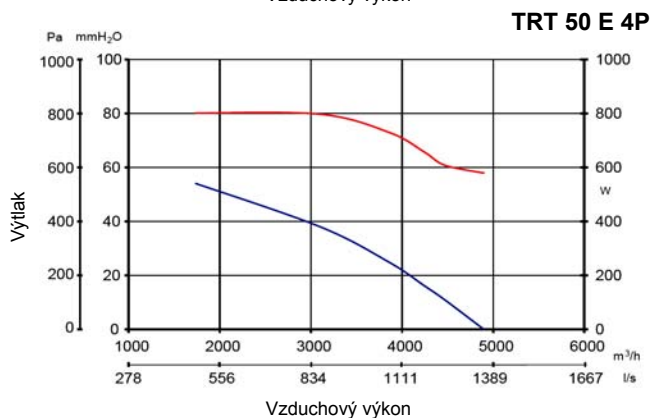
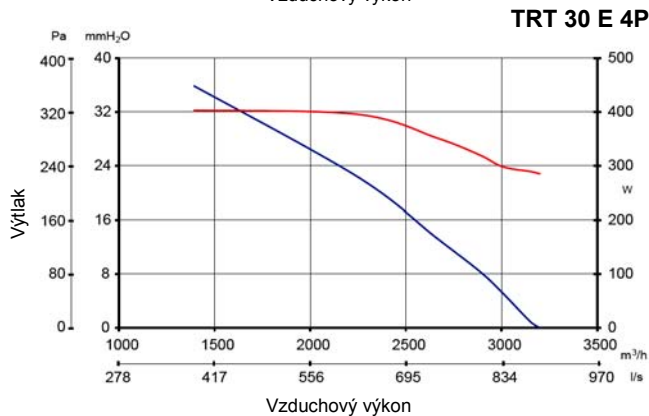
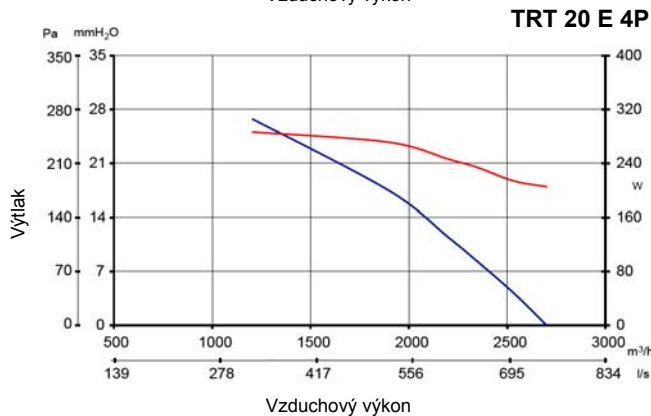
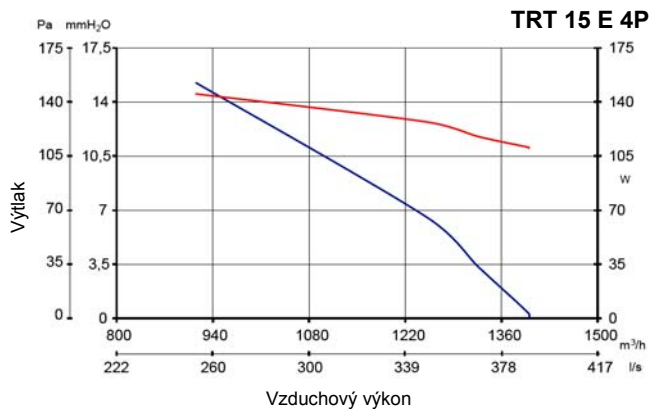
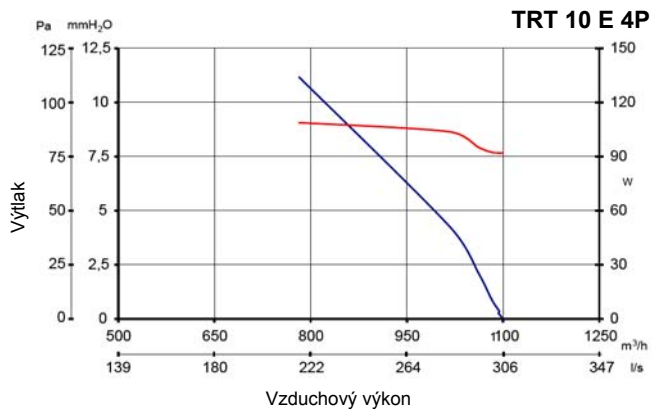

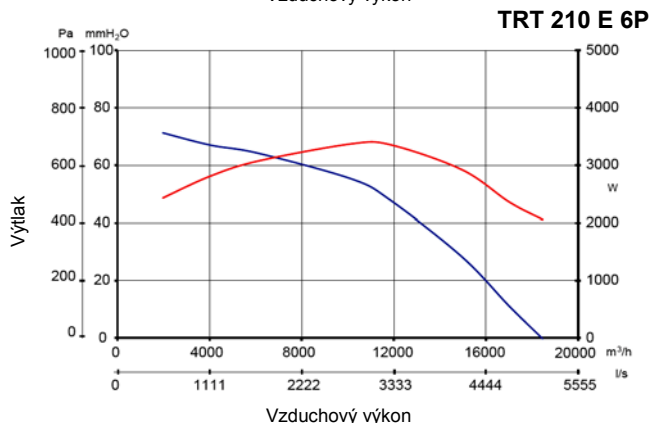
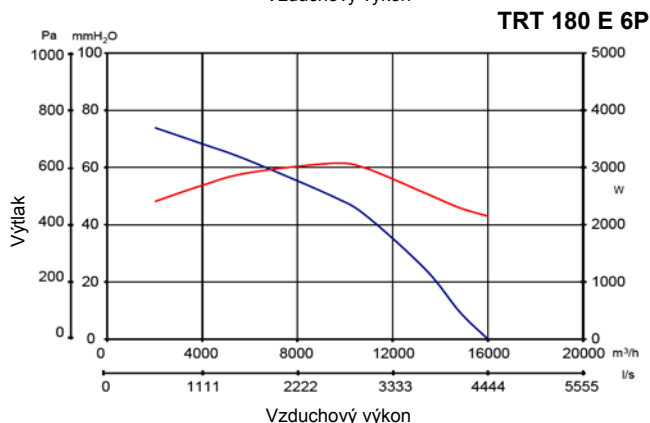
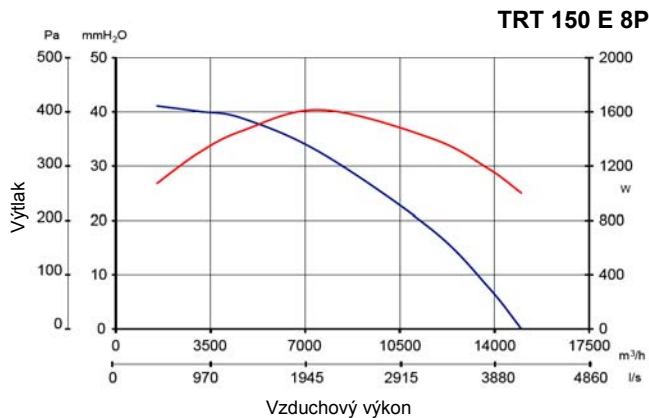
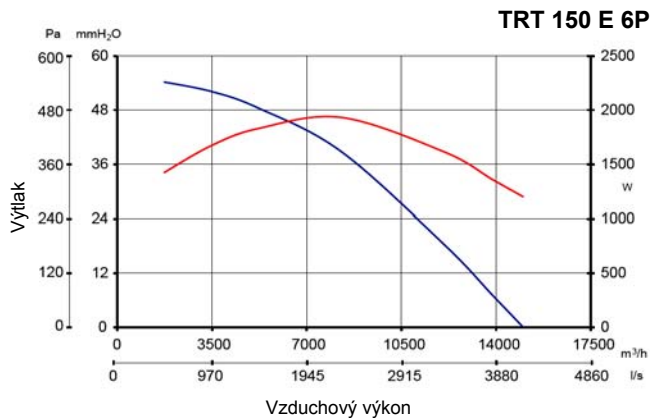

— Tlakovo - výkonová krivka  
— Krivka príkonu zariadenia

#### Kompatibilita ventilátorov a regulátorov otáčok

	Kód	C1.5	IRM 30	IRM 40	IRM 50	IRT 15	IRT 35	IRT 40	IREM 3	IREM 5	IREM 9	IRET 6	IREM INVERTER 1.4	IREM INVERTER 4.2	IREM INVERTER 7	IRET INVERTER 1.2	IRET INVERTER 2.2	IRET INVERTER 5	IREM INVERTER 8
TRM 10 E 4P	15115	X	X						X	X	X								
TRM 15 E 4P	15205	X	X						X	X	X								
TRM 20 E 4P	15216			X					X										
TRM 30 E 4P	15356			X					X										
TRM 50 E 4P	15556				X				X										
TRM 70 E 4P	15070								X	X									
TRT 10 E 4P	15155					X							X			X			
TRT 15 E 4P	15255					X							X			X			
TRT 20 E 4P	15215					X							X			X			
TRT 30 E 4P	15355						X						X			X			
TRT 50 E 4P	15555						X							X			X		
TRT 70 E 4P	15071							X				X				X			
TRT 70 E 6P	15072							X				X				X			
TRT 100 E 4P	15073							X				X			X			X	
TRT 100 E 6P	15074							X				X			X		X		
TRT 100 E 8P	15075						X					X			X		X		
TRT 150 E 6P	15076							X				X			X			X	
TRT 150 E 8P	15077							X				X			X			X	
TRT 180 E 6P	15078																		X
TRT 210 E 6P	15079																		X

#### Voliteľné príslušenstvo

- C1.5 jednofázový regulátor otáčok
- IRM (30, 40, 50) jednofázový regulátor otáčok
- IRT (15, 35, 40) trojfázový regulátor otáčok
- IREM (3, 5, 9) jednofázový regulátor otáčok
- IRET 9 trojfázový regulátor otáčok
- IREM INVERTER (1.4, 4.2, 7) - frekvenčný menič pre trojfázové modely
- IRET INVERTER (1.2, 2.2, 5, 8) - frekvenčný menič pre trojfázové modely
- TR-CU - základový rám
- TR-G - ochranná mriežka
- TR-S - spätná klapka
- TR-B - sací nástavec



Všetky výkonové údaje sú overené nezávislou skúšobňou, čo potvrdzuje štítok kvality a osvedčenie IMQ. Podlieha norme 2002/96/EC-WEEE.